

Installation Manual

CHEVROLET MAILIBU 4DR
CHE-MALI-4A

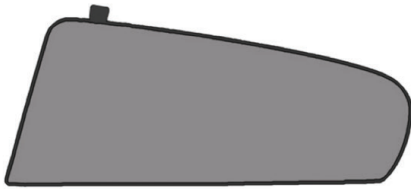

COMPONENTS INCLUDED



x 2

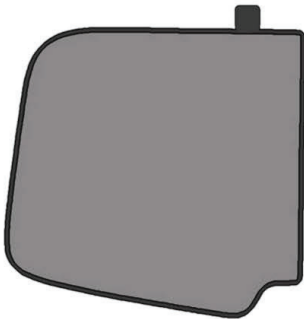

x 2

FIXING CLIPS

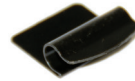

CL-M12 x 2



CL-M02 x 2

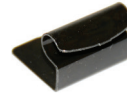

CL-M13 x 2



CL-M14 x 1



Installation

CHEVROLET MAILIBU 4DR

CHE-MALI-4A



SIDE SHADE INSTALLATION

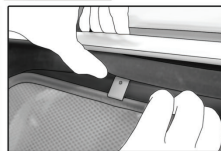
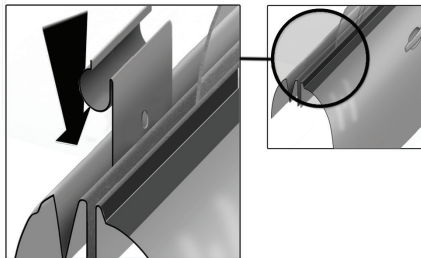
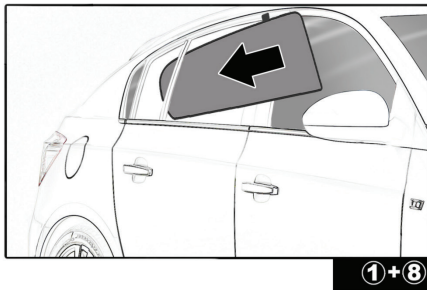
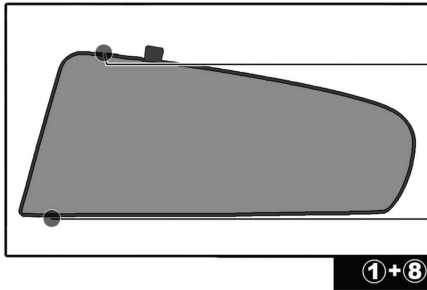

Installation

CHEVROLET MAILIBU 4DR

CHE-MALI-4A



TAILGATE SHADE INSTALLATION

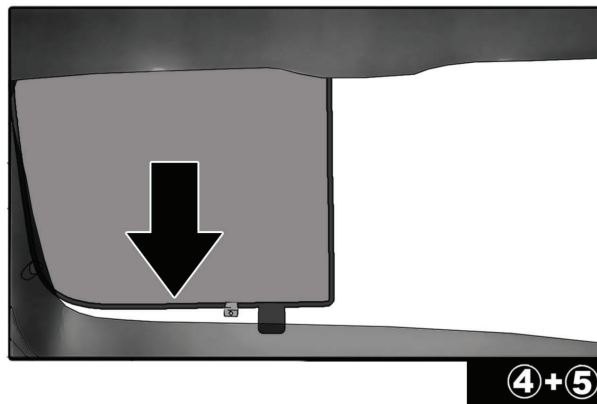
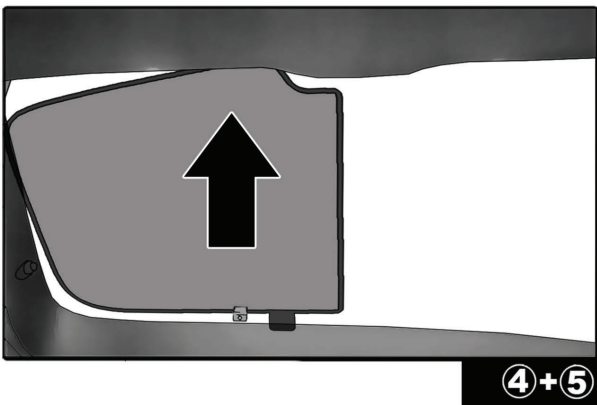
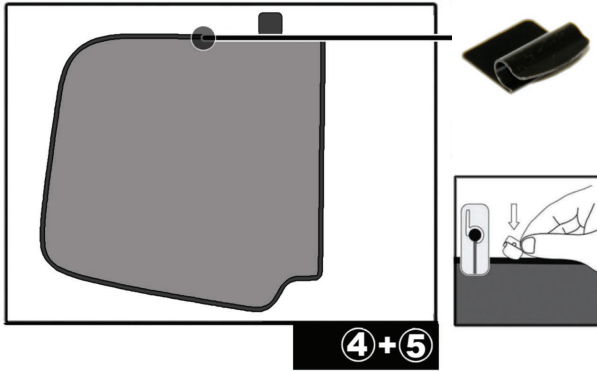

Installation

CHEVROLET MAILIBU 4DR

CHE-MALI-4A



TAILGATE SHADE INSTALLATION

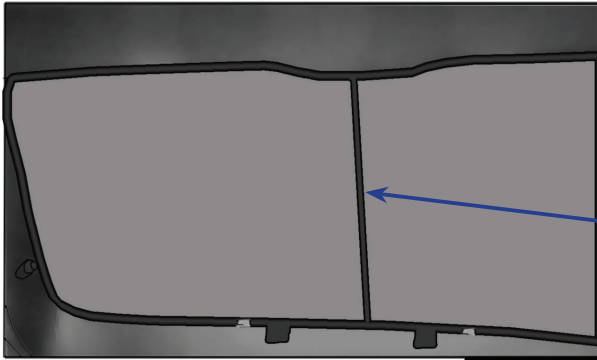

4+5

